

# QUASAR

H O L L A N D

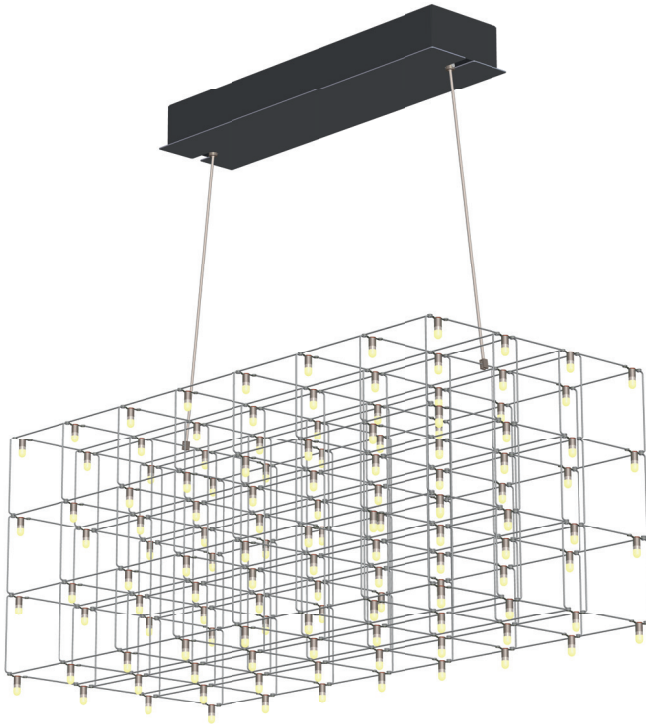

## **Universe Square Double / Triple**

NL Installatie handleiding

DE Installationsanleitung

EN Installation manual

# 1 NL Informatie / DE Information/ EN Information

## Veiligheidsinformatie



- Onderbreek altijd de stroomtoevoer door verwijderen van de toestelzijdige stop bij de montage, onderhoudswerk en het verwisselen van de gloeilampen.
- Een brandende lamp is heet. Let op brandgevaar.
- De lamp mag niet op geleidend materiaal worden gemonteerd.
- Draag geen sieraden bij onderhoudswerkzaamheden.
- Geen (decoratie) materialen aan het armatuur bevestigen.

## Technische informatie



IP20



LED

0,5m



- Ingangsspanning 120V of 240V
- Uitgangsspanning 12V
- Beschermingsklasse I
- Beschermingsgraad IP20
- De lamp mag niet in openlucht gebruikt worden
- Gloeilamp: 12V, 1.2W  
Krypton: 12V, 2W  
LED: 12V, 0.3W, 2700K, CRI 80
- Ten minste een afstand van 0,5m tenopzichte van het bestraalde oppervlakte houden.
- Technische gelijkvormigheid volgens EN-Richtlijnen

## Onderhoudsinformatie



- De lampen reinigen met in de handel verkrijgbare, niet-agressieve en niet-schurende reinigingsmiddelen
- Gebruik een plumeau

## Sicherheitshinweise

- Bei Montage, Wartungsarbeiten und Leuchtmittelwechsel immer Stromzufuhr durch Entfernen der bauseitigen Sicherung unterbrechen.

Wenn die Leuchte in Betrieb ist, besteht beim Glühmittel Verbrennungsgefahr!

- Leuchte darf nicht auf leitende Materialien montiert werden.
- Kein Juwelen während wartung tragen.
- Kein (dekorations) Materialien an die Leuchte befestigen.

## Technische Hinweise

- Eingangsspannung 120V oder 240V
- Ausgangsspannung 12V
- Schutzklasse I
- Schutzart IP20
- Leuchte darf nicht im Freien verwendet werden.
- Glühbirne: 12V, 1.2W  
Krypton: 12V, 2W  
LED: 12V, 0.3W, 2700K, CRI 80
- Mindestabstand zur angestrahlten Fläche 0,5m
- Technische Konformität gemäß EU-Richtlinien

## Pflegehinweise

- Leuchten nur mit handelsüblichen, nicht aggressiven und scheuernden Reinigungsmitteln reinigen.
- Gebrauch eine Federbesen

## Safety information

- During installation, maintenance work and change of illuminants always interrupt the power supply by removing the respective circuit breaker.

When switched on, the lamp may cause burns when touched.

- Lamp may not be mounted on conductive materials.
- Don't wear jewelry during maintenance.
- Don't use decoration materials in the lamp.

## Technical data

- Input voltage 120V or 240V
- Output voltage 12V
- Safety class I
- Degree of protection IP20
- Lamp must not be used in the open.
- Light bulb: 12V, 1.2W  
Krypton: 12V, 2W  
LED 12V, 0.3W, 2700K, CRI 80
- Minimum distance from illuminated surface 0.5m
- Technical conformity according to European EN-Regulations

## Maintenance information

- Lights should only be cleaned using commercially available, non-aggressive, non-scouring cleaning agents.
- Use a feather duster

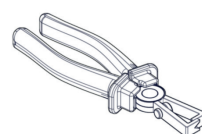
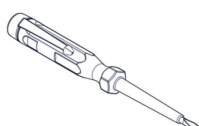
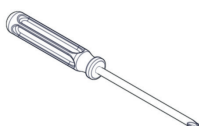
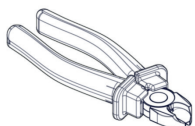
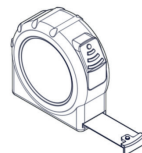
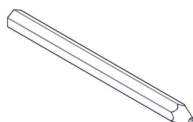
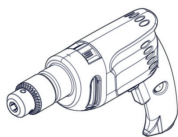
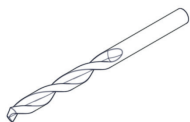

**QUASAR**  
H O L L A N D

## 2.1 NL Installatie / EN Installation / DE Installation

---

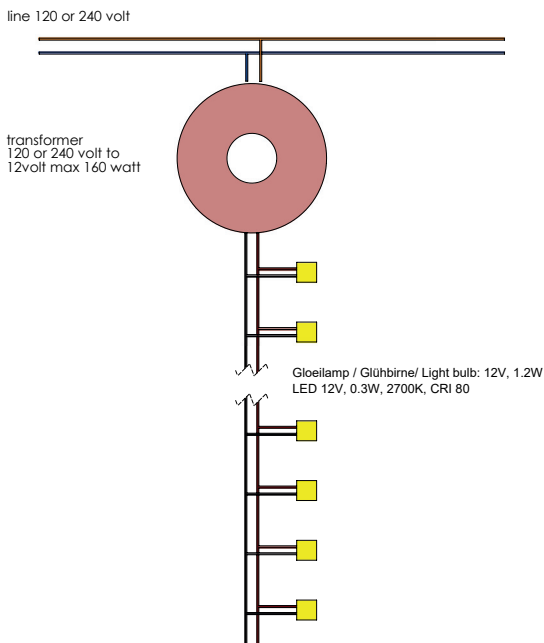

## 2.2

---

### Universe Square Double = 96 bulbs

Gloeilamp / Glühbirne / Light bulb total = 115.2 Watt

LED total = 28.8 Watt

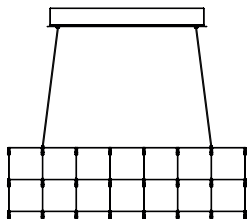

### Universe Square Triple = 128 bulbs

Gloeilamp / Glühbirne / Light bulb total = 153.6 Watt

LED total = 38.4 Watt

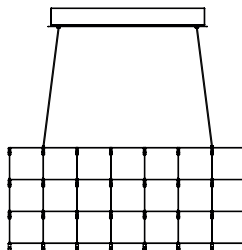

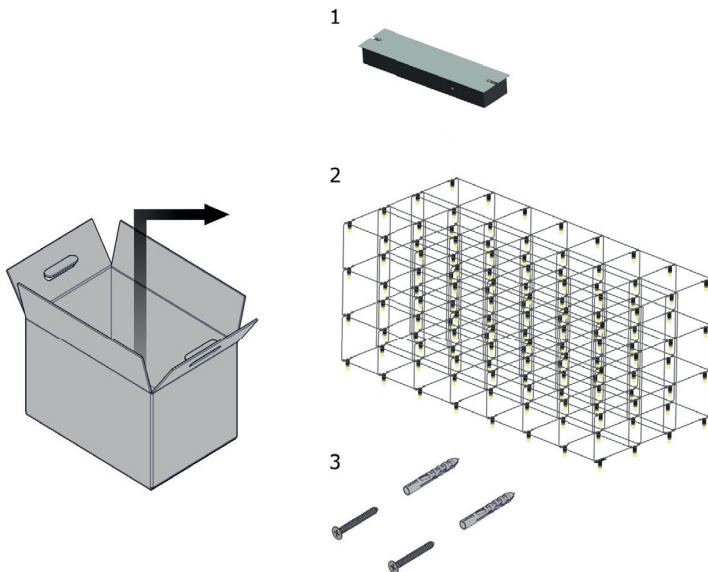

---

2.4

---

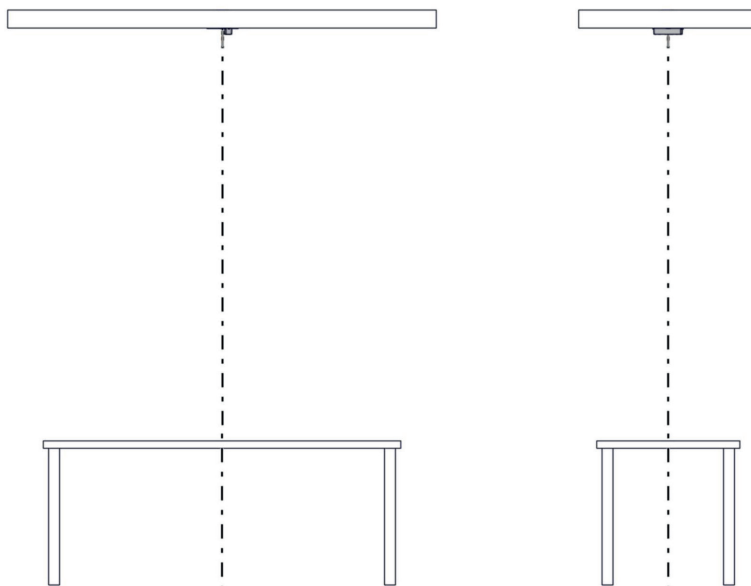

## 2.5 NL Installatie / EN Installation / DE Installation

---

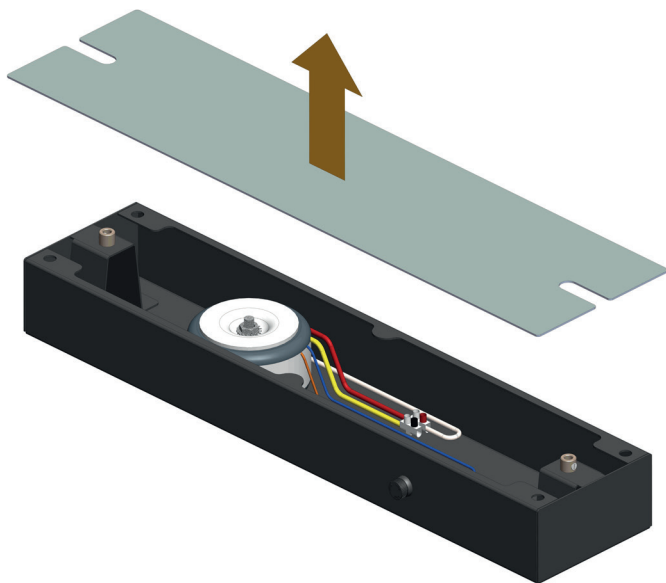

## 2.6

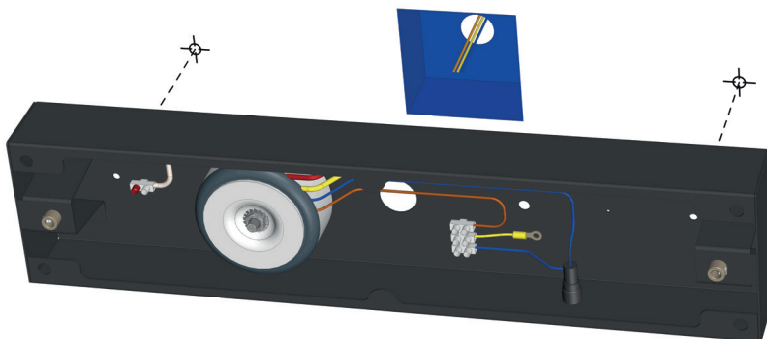
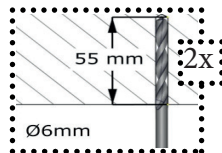
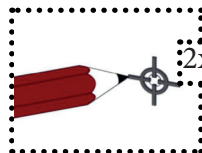
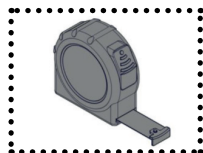

## 2.7 NL Installatie / EN Installation / DE Installation

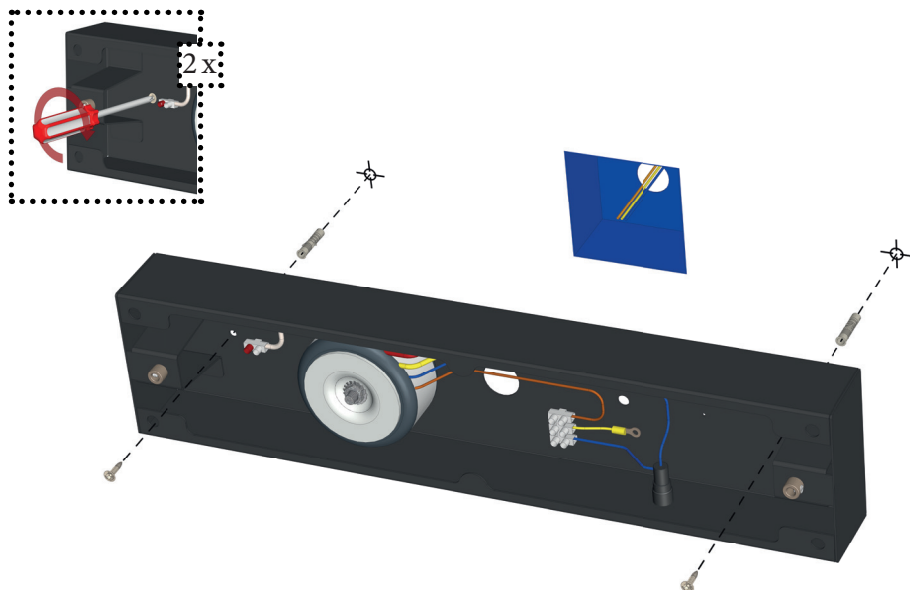

## 2.8

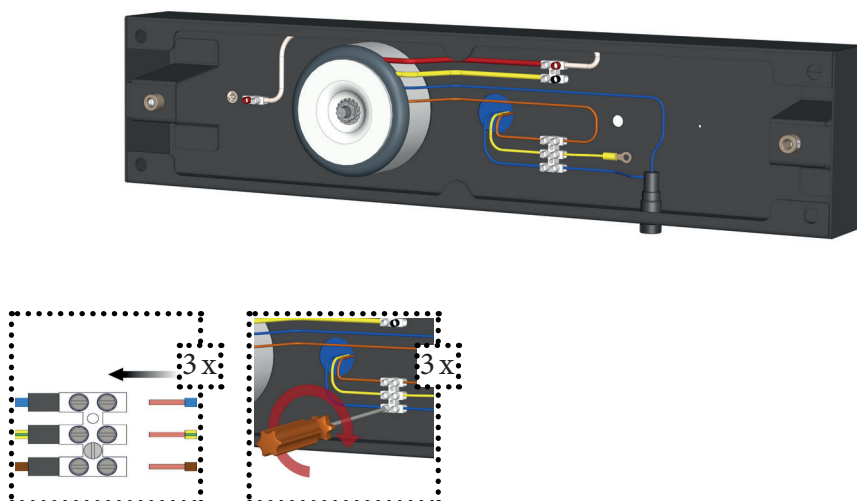

2.9 NL Installatie / EN Installation / DE Installation

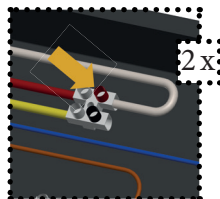
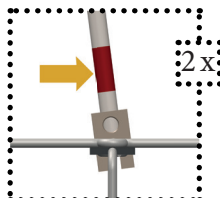
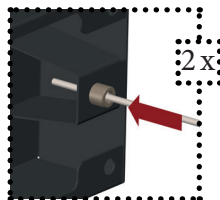
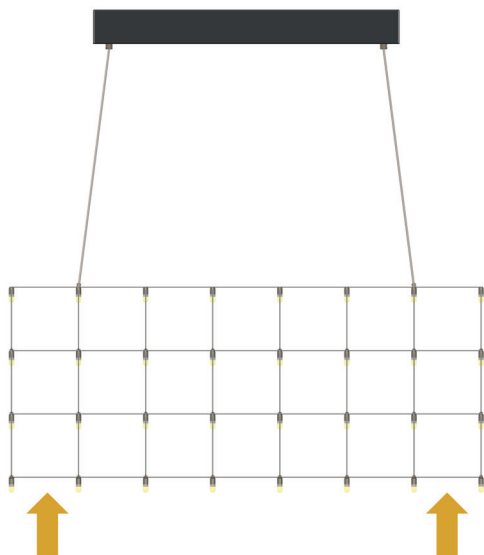

2.10

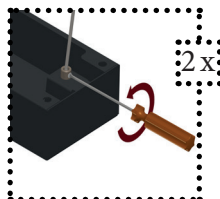
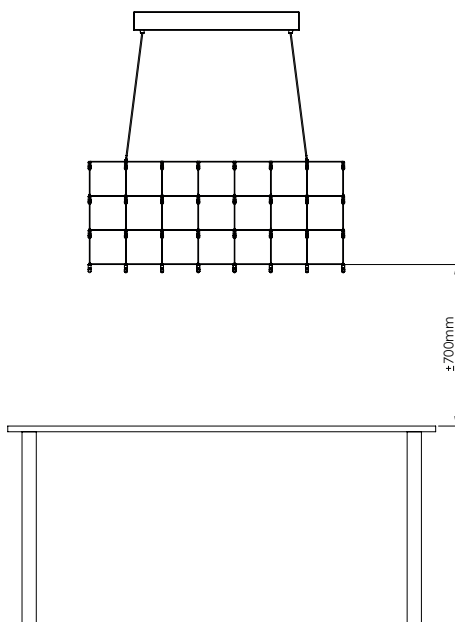

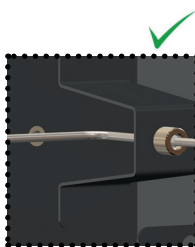
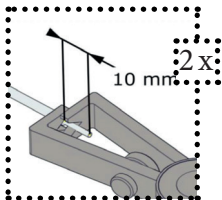
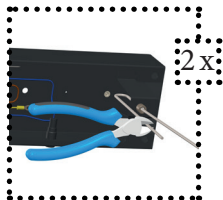

2.12

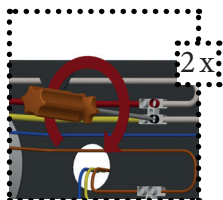



2.13 NL Installatie / EN Installation / DE Installation

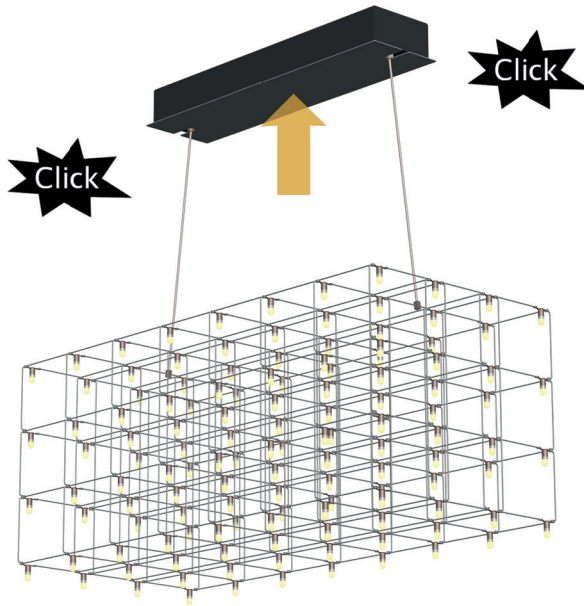

2.14

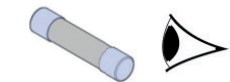
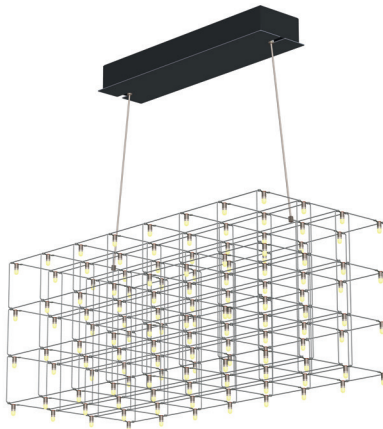
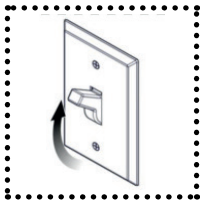

Zie zekering voor type  
See fuse for type  
siehe zum Sicherungstyp





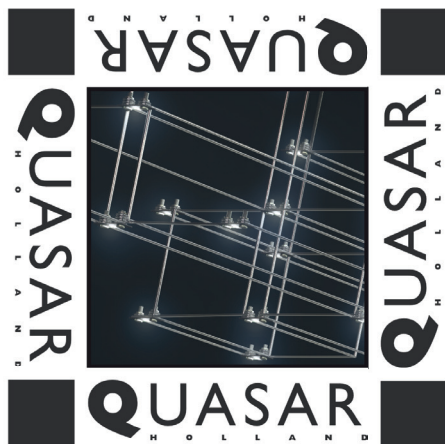

Quasar Holland B.V.  
Burgstraat 2  
4283 GG GIESSEN  
THE NETHERLANDS

T. 31-183-447887  
E. [info@quasar.nl](mailto:info@quasar.nl)  
I. [www.quasar.nl](http://www.quasar.nl)

Date: 17-07-2017  
Version: 1